

RoHS Compliant

此处壳子缺角以实物为准

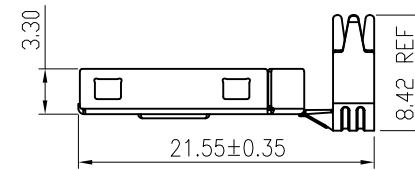
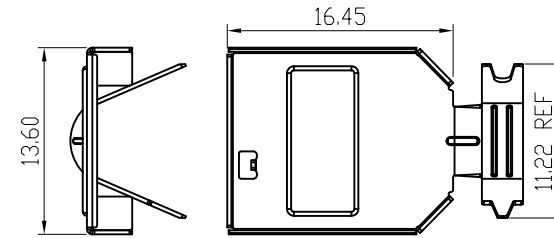
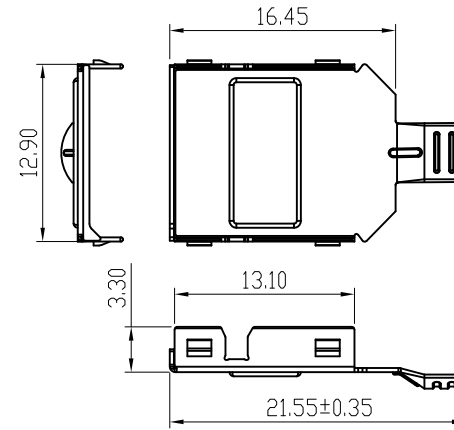
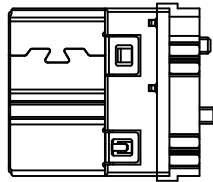
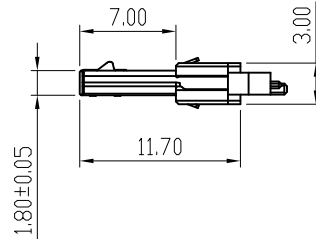
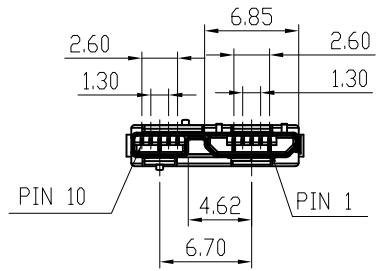
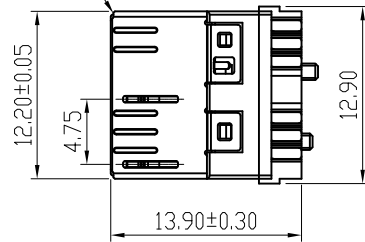

7	HOOK	2	SUS304	
6	BOTTOM SHELL	1	SPCC	NICKEL PLATED
5	TOP SHELL	1	SPCC	NICKEL PLATED
4	FRONT SHELL	1	BRASS	NICKEL PLATED
3	COVER	1	LCP	UL 94V-0
2	TERMINAL	10	PHOSPHOR BRONZE	GOLD/TIN PLATED
1	HOUSING	1	PBT	UL 94V-0
NO.	TITLE	Q'TY	MATERIAL	REMARK

NOTE:

\*Electrical Characteristics;

- CONTACT RESISTANCE: 30mΩ MAXIMUM
- CONTACT CURRENT RATING: 1.5A
- DIELECTRIC WITHSTANDING VOLTAGE: 100 V R.M.S.
- INSULATION RESISTANCE 100 MEGOHMS MIN

\*Mechanical Characteristics;

- MATING FORCE: 3.57kg MAX
- UNMATED FORCE: 1.02kg MIN

ECN. NO	REV	DATE	DESCRIPTION	CHANGED	APPROVED	UNIT: mm
	A	17.09.13	新增规格	Y.XW	KIM	

▼ = Places	TOLERANCES UNLESS	
DIM NO. Ⓢ	X. ± 0.50	X° ± 3'
SCALE: 1:1	.X ± 0.30	.X° ± 2'
SHEET: 1 OF 1	.XX ± 0.25	.XX° ± 1'
	.XXX ± 0.10	.XXX° ± 0.5'

Coorle 库乐科技

DESIGN: ELISA	DATE:	Micro USB 3.0 B公 超薄长壳 三件式(全通槽)
CHECKED:	DATE:	PART NO:
APPROVED:	DATE:	SIZE: A4
		REV: A

